



## PAULI BETON N.V.

Industrielaan 19

B-3730 Hoeselt

Tel. +32(0)89/41.13.00

Fax. +32(0)89/41.67.19

Email : info@paulibeton.be

## WPR 13/60 - Welfsel Pauli Ruw

605 **BENOR** 225

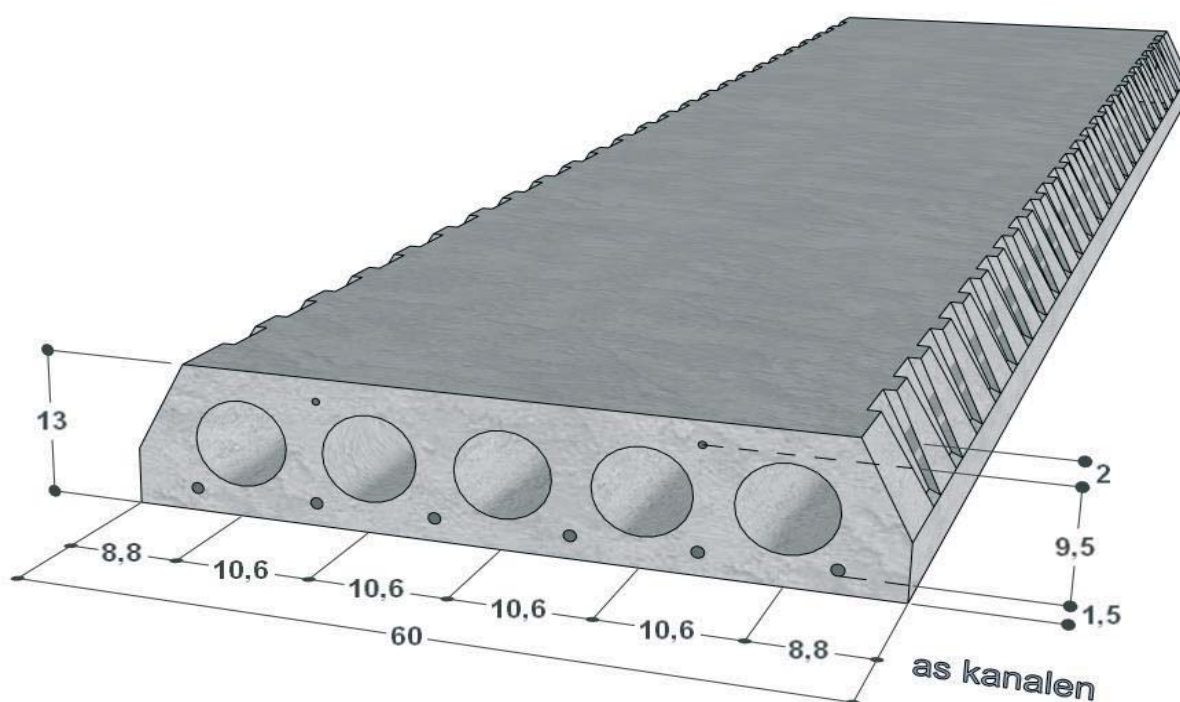

### Technische gegevens

Holle welfsels in gewapend beton

Onderzijde : RUW

Dikte : 13 cm

Breedte : 60 cm

Rf = 30 min (1h. op bestelling)

Passtukken : 30-40-50 cm

Eigen gewicht : 200 kg/m<sup>2</sup>

Vulbeton : 9 l/m<sup>2</sup>

Lengte per 10 cm

Max. Lengte : 5,50 m